

Thule Rapid System Kit 1592

> Instructions

VOLKSWAGEN Passat, 4-dr Sedan, 05-09, 10-14 / *06-

*North America

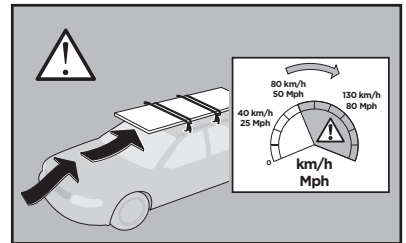
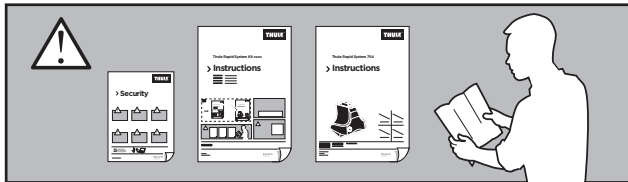
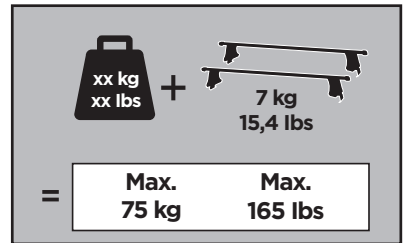
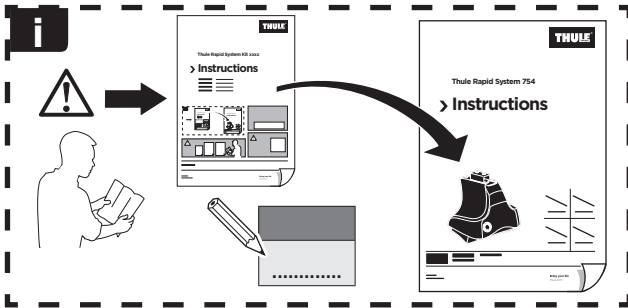

ISO 11154-E

141592

C.20150415
519-1592-04

Bring your life

thule.com



163 x2

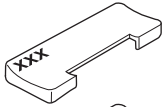

164 x2

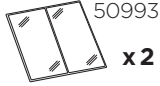
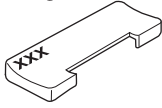

50993

x2



725 x1

726 x1

1094 x1

1095 x1



x1

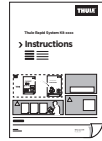

x1

1

	X (scale)	X (mm)	X (inch)
VOLKSWAGEN Passat, 4-dr Sedan, 05-09, 10-14 / *06-	40,5	1056	41 5/8

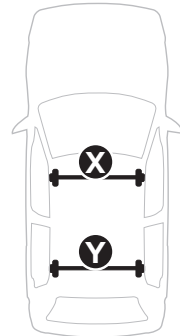
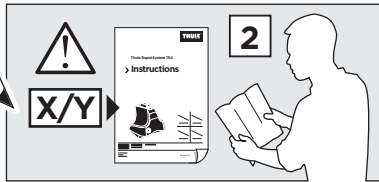
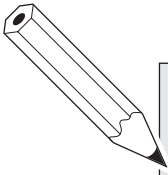

	Y (scale)	Y (mm)	Y (inch)
VOLKSWAGEN Passat, 4-dr Sedan, 05-09, 10-14 / *06-	39	1041	41

2

VOLKSWAGEN **Passat**, 4-dr Sedan, 05-09, 10-14 / *06-

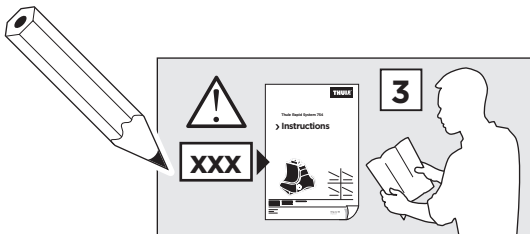
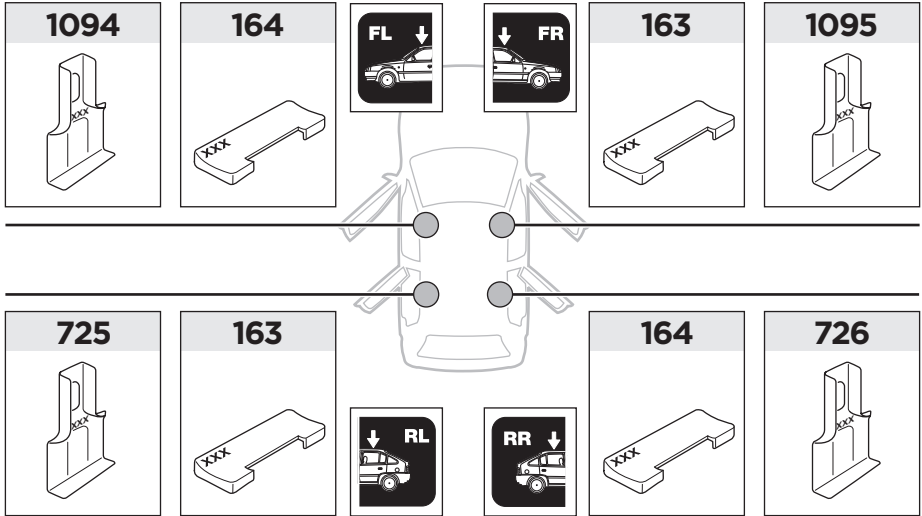

3

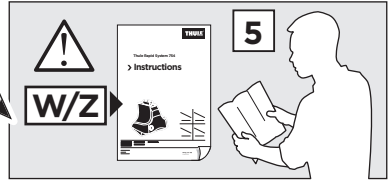
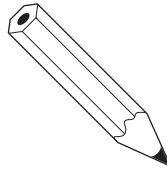

	W (mm)	Z (mm)	W (inch)	Z (inch)
VOLKSWAGEN Passat , 4-dr Sedan, 05-09, 10-14 / *06-	270	775	10 ⁵/₈	30 ¹/₂

